



Simphoenix

E280 Series Vector Control Universal Inverter



CE SGS





Simphoenix

Shenzhen Simphoenix Electric Technologies Co.,Ltd was established in 2004, specialized in the R&D, production, sales and service of industrial automation products. Simphoenix is committed to be a reliable industrial automation product and solution provider, mainly include inverter, servo drive, servo motor, PLC, HMI, PMSM etc. Trough 10 years' development, Simphoenix has become a well-known domestic brand for its complete product structure and strong R&D capacity.



Shenzhen Simphoenix Electric Technology Co.,Ltd

Product Introduction

Classic Inheritance

E280 is developed on the basis of our E series inverter which originally launched in 2004. Through field test of more than 1.2 million inverters, continuous improvement and optimization of four generation products, stability and reliability has become the key character of our E series products.



Innovation • Transcendence

Simphoenix isn't content to simply inherit classic while keeping the consistent high stability and reliability. By introducing more extensive control algorithms and application functions, the application scope of E280 series inverter has been largely broadened, its effect on machine tool, chemical, cable machine, conveyor etc has been greatly improved, also can be freely applied to higher demand occasions, like hoist, rolling machine, construction machine etc.

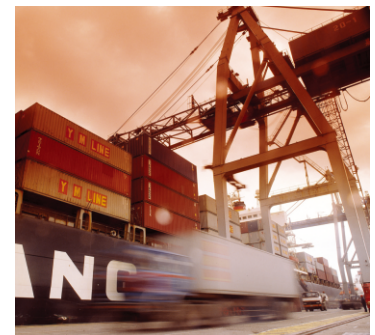

Product Upgrade and Change

Stronger Software Function

E280 series inverter software has been significantly upgraded, can easily meet the needs of cutting, engraving and milling industry etc. Application macro parameter, virtual DI, DO terminals, mapping access parameter, built-in PID function, frequency setting channel, analog input disconnection detection, strong start current function etc are added to E280 series inverter.

Application Macro Parameter

It can easily set and cure general parameter for several industries, which helps to simplify parameter setting for some specific application occasions. Common patterns include two-wire control mode, three-wire control mode, machine tool spindle drive mode etc.

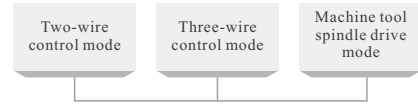

Virtual I/O Terminal

16 channel virtual I/O terminal helps to simplify external wiring of some complicated application occasions, and helps the control circuit to avoid the possibility of being interfered, which equips to extend the external terminals in a certain extent.

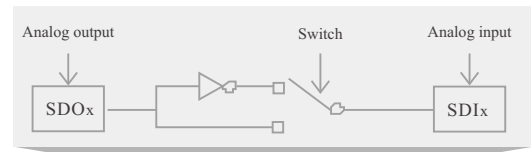

Mapping Access Parameter

By setting mapping access function parameter, an instruction can continuously read multiple parameters. When use upper machine to communicate with inverter, it helps to gain multiple discontinuous parameters more quickly and easily.

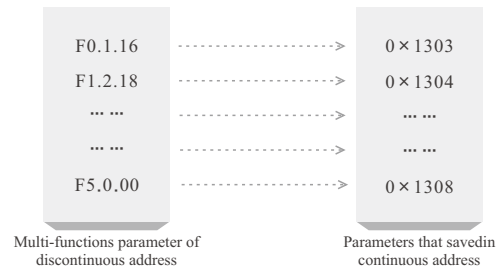

Built-in PID Function

E280 series inverter has built-in PID controller to match up frequency given channel selection, user can realize auto tuning of process control, achieve constant temperature, constant voltage and tension control etc.

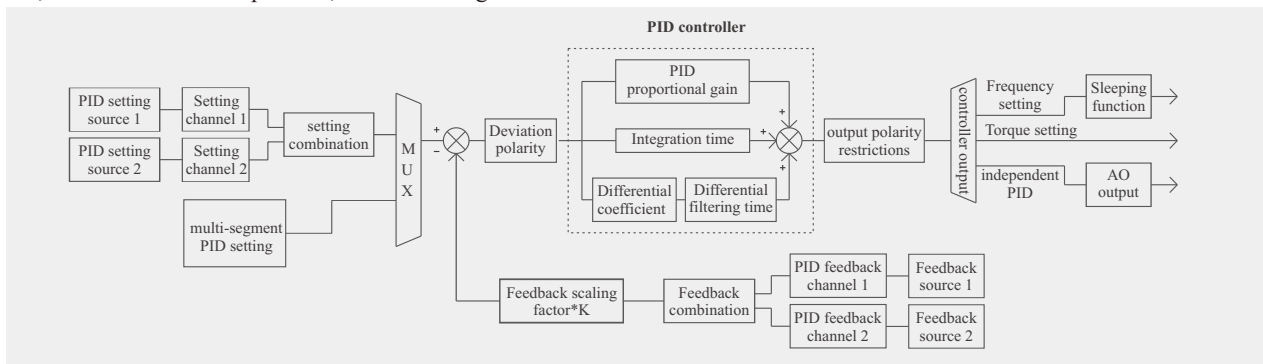

Frequency Setting Channel

Increased frequency bipolar preset, virtual analog quantity preset, process PID output preset.

Superior Control Performance

Compared with E380 series, E280 series possess more control algorithms, and have greatly improved in start torque, speed range, steady speed precision, torque control precision, torque response time, etc.

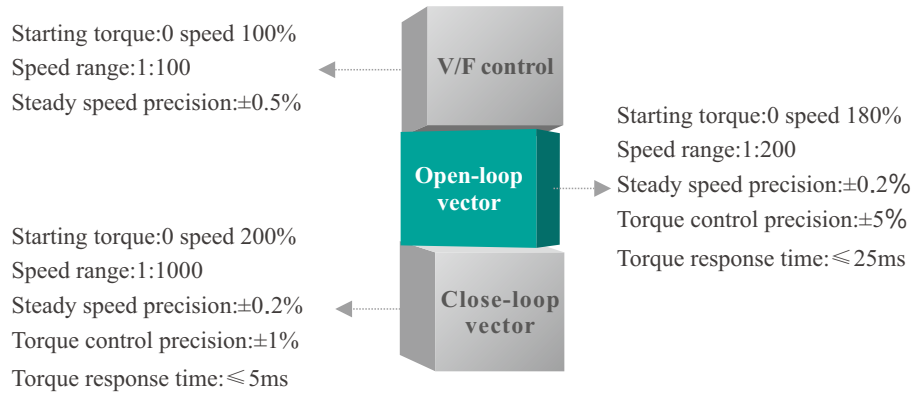

More Compact and Beautiful Structural Design

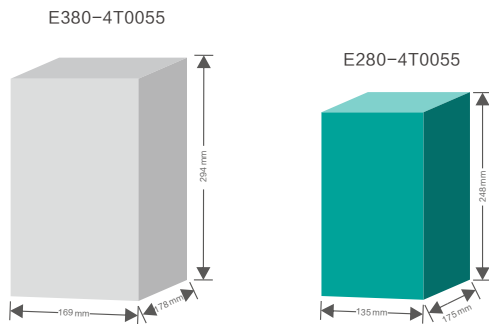

Whole E280 series' structure significantly reduce comparing with E380 series which enhanced spatial utilization efficiency of electric cabinet, and better for dissipating heat of internal component.

*Compared with E380 series, E280 series possess a volume reduce of **10%~56%**

Higher Product Test Standard

The following table provide main item testing result of E280 series product safety and EMC

Test item		Test result	Reference standard
Insulation Resistance		>1MΩ	GB12668
Compressive strength		2.5KVAC,60s leakage current≤1mA	GB12668
ESD	Contact discharge	±4KV	EN61000-4-2
	Air discharge	±8KV	
	Coupling discharge	±4KV	
EFT	RST	±4KV	EN61000-4-4
	UVW	±2KV	
	Signal line	±2.5KV	
Power line surge	Interphase	±2KV	En61000-4-5
	Reversely	±4KV	
CS test (Frequency range150KHz~80MHz)		10V(e.m.f)	EN61000-4-6

Product Upgrade and Change

More Plentiful I/O Ports--oriented Industry 4.0

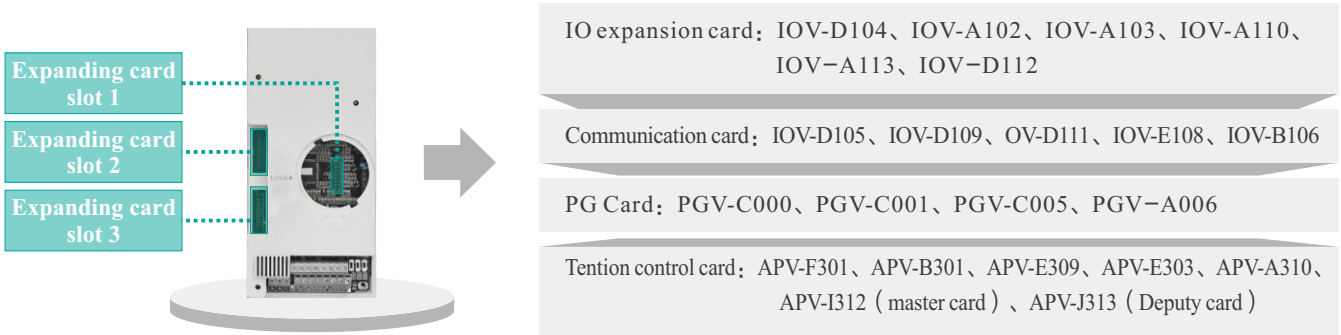

Support Modbus-RTU、Profibus-DP、CANopen Bus protocol

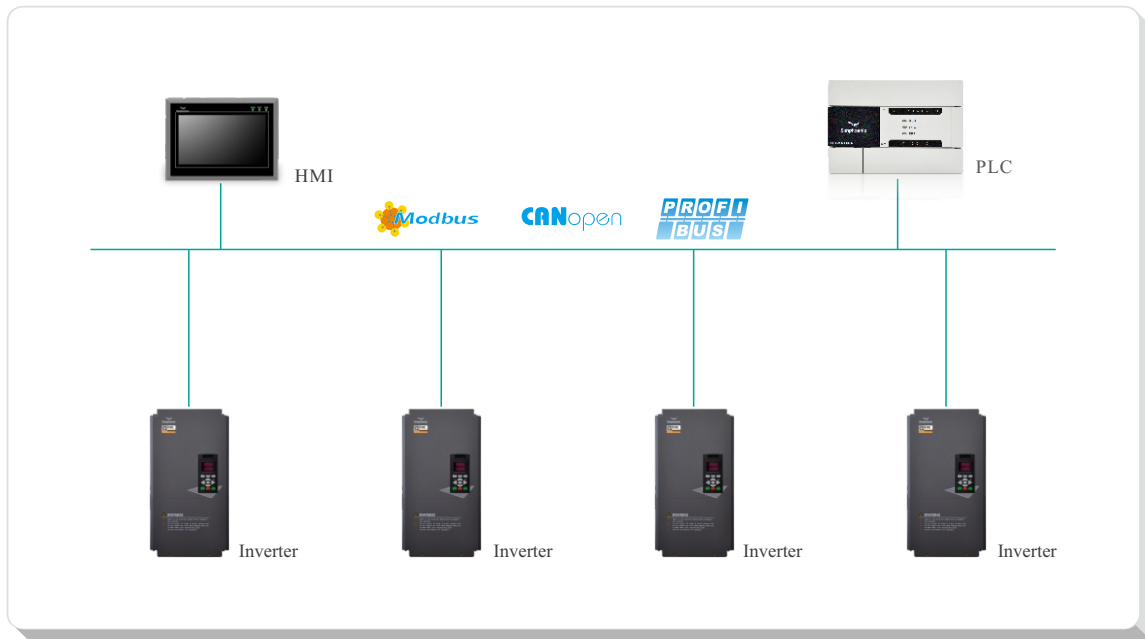

Model Descriptions

E280 - 4 T 0150 G

(A) (B) (C) (D) (E)

<p>(A) Product Series E280: Vector Universal Inverter</p>	<p>(C) Power Supply Phase T: Three Phase S: Single Phase</p>	<p>(D) Power Grade (KW) 0011 : 1.1 0030 : 3.0</p>
<p>(B) Voltage Grade 2: 220V 4: 380V</p>	<p>(E) Load Type G: Universal P: Stable</p>	<p>. 3150 : 315</p>





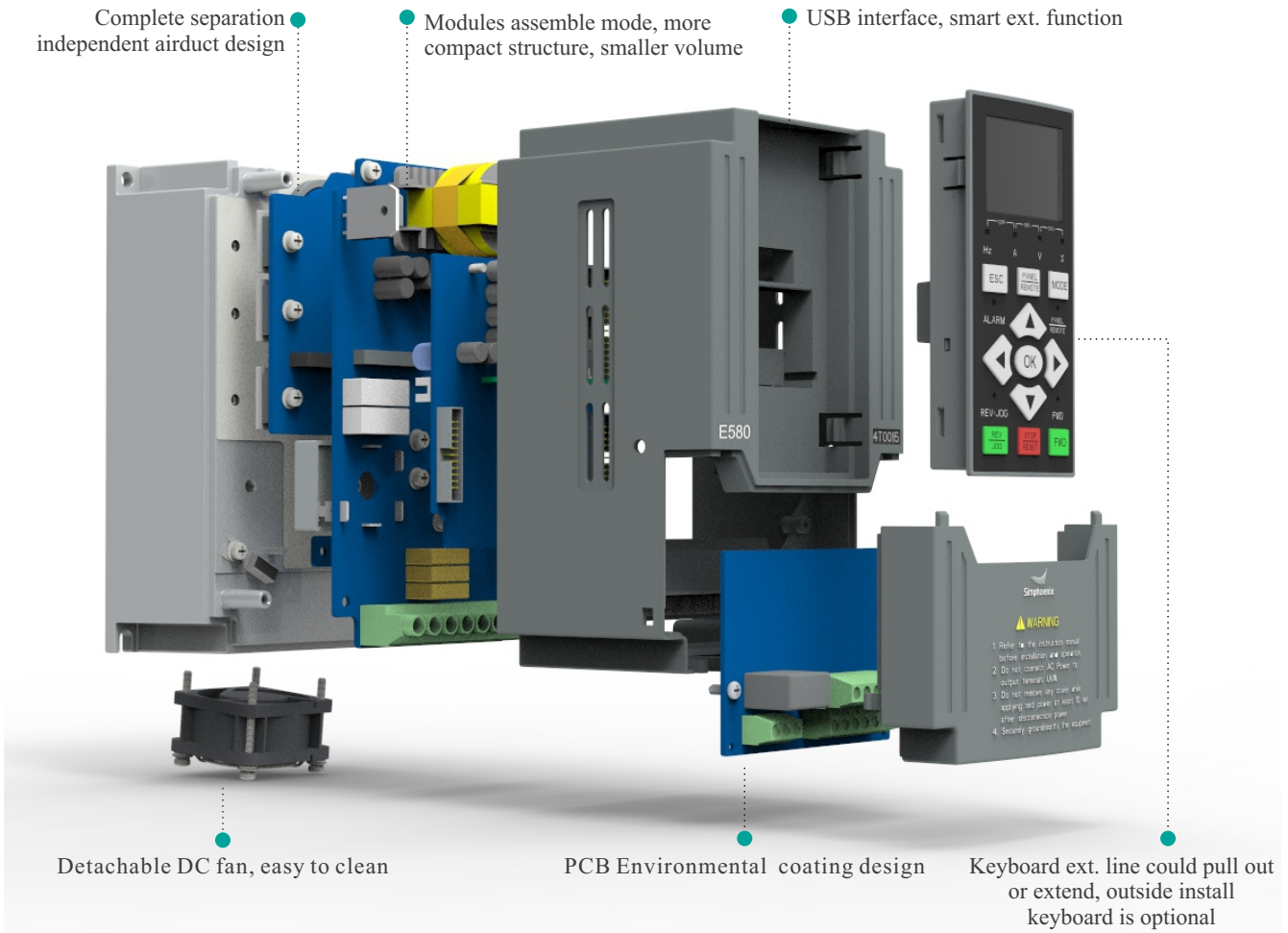

Product Structure

- α Adopt DC fan cooling, good heat dissipation, stable performance, easy to disassembly and clean
- α Intensive double-deck tri-proof lacquer treatment process, ensure safety and reliability of circuit.



Our constant efforts ensure better user experience of our product.

Optional Keypad

Installation	Apply E280-4T0040 and paver below	Apply E280-4T0040 and paver above
	 DPNL350EN  DPNL350EM	 DPNL360CB  DPNL360CA  DPNL360EB  DPNL360EA

Wiring Diagram

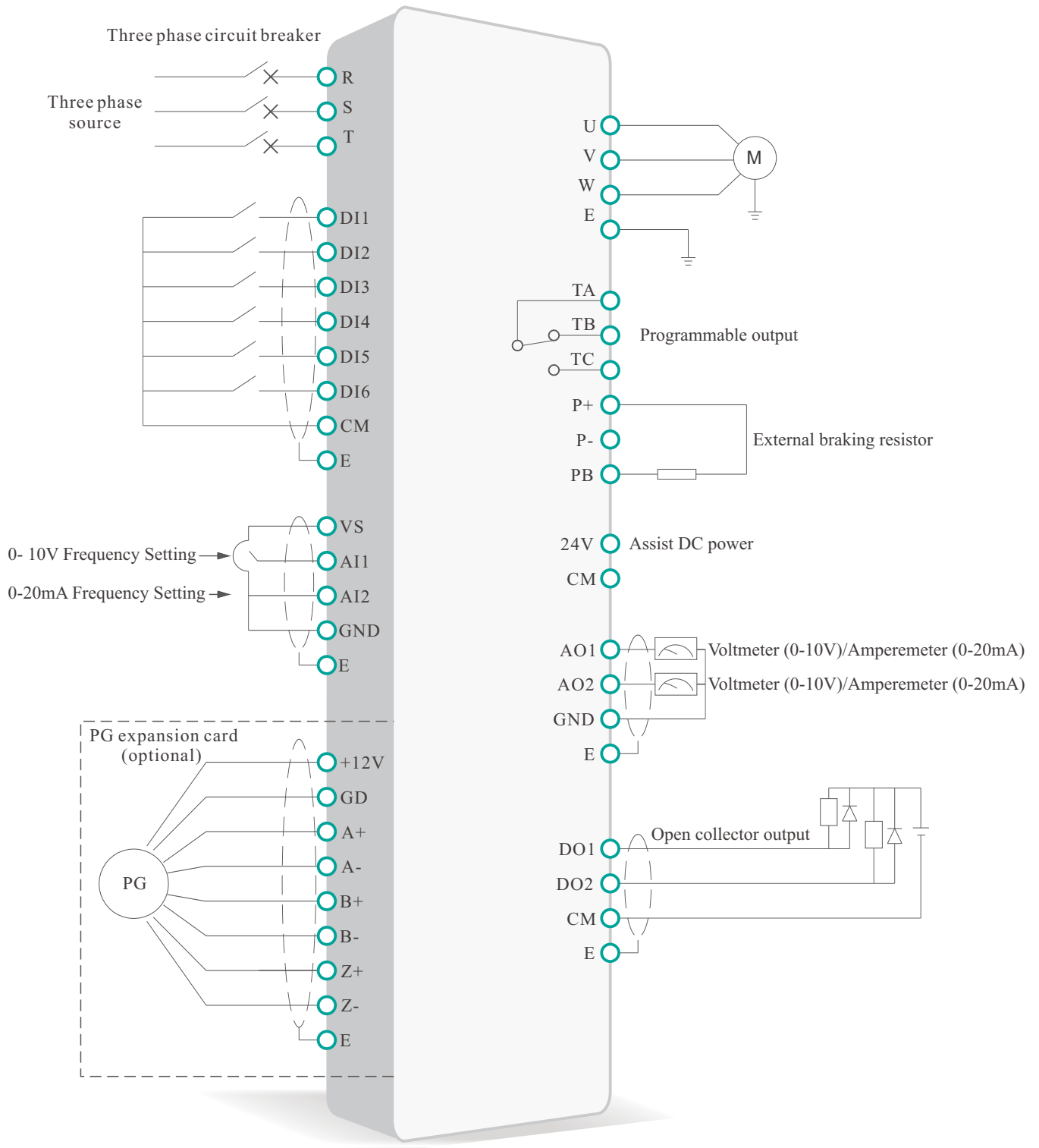

Technical Specifications

Input and Output	Input Rated Voltage	3AC 380V ±15%		
	Input Frequency	50/60 HZ ±15%		
	Output Voltage	0 V ~ input rated voltage		
	Output Frequency	Low frequency running mode: 0.00~300.00Hz; High frequency running mode: 0.00~400.00Hz;		
	Digital Input	E280-4T0040 and below units (extension unable, optional): Standard built-in 5 digital input (DI) E280-4T0055 and above units (extension available): Standard built-in 6 digital input (DI) Extension to 9, one is for high-speed digital input (extension set optional)		
	Digital Output	E280-4T0040 and below units: Standard built-in 1 digital output (DO) E280-4T0055 and above units: Standard built-in 2 digital input (DO) Be able to extend 1 high-speed DO output (0~100Khz)		
	Pulse Input	0 ~ 100.0KHz pulse input. Connect NPN type OC output (optional)		
	Pulse Output	0 ~ 100.0KHz pulse NPN type OC output (optional)		
	Analog Input	E280-4T0040 and below units (extension unable, optional): Standard built-in: 0 ~ 10V voltage input (Ai1), 0 ~ 20mA current input (AI2); E280-4T0055 and above units (extension available): Standard built-in: 0 ~ 10V voltage input (Ai1), 0 ~ 20mA current input (AI2); Be able to extend 1 AI (-10V~10V dual polarity voltage input);		
	Analog Output	E280-4T0040 and below units (extension unable, optional): Standard built-in: 1 0 ~ 10V analog output signal (0 ~ 20mA current output mode optional) E280-4T0055 and above units (extension available): Standard built-in: 2 0 ~ 10V analog output signal (0 ~ 20mA current output mode optional)		
Contact Output	Standard one set AC 250V/1A normal open, normal contact, able to extend 1-6 sets normal open and normal close contact.			
Control Characteristics	Control Mode	Closed-loop Vector Control	Open-loop Vector Control	V/F Control
	Start Torque	0 Speed 200%	0 Speed 180%	0 Speed 100%
	Speed Adjustment Range	1:1000	1:200	1:100
	Stable Speed Accuracy	±0.02%	±0.02%	±0.5%
	Torque Control Accuracy	±1%	±5%	--
	Torque Responding Time	≤5ms	≤25ms	--
	Frequency Resolution	Low frequency running mode: 0.01Hz;High frequency running mode: 0.1Hz		
	Frequency Accuracy	Low frequency running mode: digital set—0.01Hz, analog set—highest frequency×0.1% High frequency running mode: digital set—0.1Hz, analog set—highest frequency×0.1%		
	Overload Capability	G type: 110%--long term; 150%--90s; 180%--2s;		
		P type: 105%--long term;		
	Carrier Wave Frequency	Three phase voltage vector combined mode: 1.5~10.0KHz; Two phase voltage vector combined mode: 1.5~12.5KHz; (high frequency mode can be 15Khz)		
	Acc. And Dec. Time	0.01~600.00 Sec./0.01~600.00Min.		
	Magnetic Flow Braking	By increasing motor magnetic flow (30~120% available), motor can achieve fast decreasing braking.		
DC Braking / Band Brake	Initial frequency of DC braking / bank brake: 0.0~upper frequency, braking / bank brake injecting current 0.0~100.0%			
Start Frequency	0.0~50.0Hz			

Technical Specifications

Typical Function	Multi-step running	15 frequency / speed running, each running direction, time, acc or dec set independently. 7 process PID set (PID control function cancel or not)
	Built-in PID	Built-in PID controller, able to be used by external equips.
	Awakening sleep	Built-in PID with simple sleep and awakening function
	MODBUS Communication	Standard MODBUS communication protocol (optional), flexible parameter read-write mapping function
	Dynamic Braking	Acting voltage: 650~760V, braking rate: 50~100%
	General Function	Reset after power stop, recovery with failure, motor parameter dynamic / static self-identification, start enable, running enable, start delay, over-current inhibit, over-voltage / low-voltage inhibit, V/F self-defined curve, analog input wave rectification, power-off test, textile machine disturbance (swing frequency) operation
	Communication Linkage Synchronization	It is easy to achieve synchronous drive for several equips with free selection based on current, torque, power to reach linkage balance.
	Overload Dynamic Balance	It can achieve multi-equip's overload dynamic balance (not limit to communication linkage) to reach torque motor characteristics.
	Strong Start Torque	For the load with strong inertia, static friction, it can set super strong start torque for certain time.
	Setting Priority	User can select priority sequence for all kinds of frequency / rotate speed setting channels freely which is suitable for kinds of combined applications.
Setting Combination	Hundreds of setting combination of frequency, rotate speed, torque etc.	
Unique Function	Timer	Built-in 3 timers with 5 kinds of clock and 6 kinds of startup trigger modes Several door control signals and working modes, 7 output signals
	Counter	2 inner counter, 3 counting pulse edge selection, 6 start trigger modes, 7 output signals
	Macro Parameter	Application macro: Easy for setting and partial solidifying several usual parameter groups, simple parameter setting for general applications.
		System macro: Convenient for switching equip.'s running mode (ex. Switching with high and low frequency running mode), Self-defined partial parameters
	Parameter Debugging	Adjust any non-stock parameters with one button stock or give up and recovery
Parameter Display	Shield non-use parameter modules automatically, or display revised, stock, changed parameters selectively.	
Protection Function	Running Protection	Over-current protection, over-voltage protection, short circuit protection, inverter over-heat protection, inverter overload protection, motor overload protection, output lack of phase protection
	Equip Abnormal	Current check abnormal, EEPROM storage abnormal, control unit abnormal, motor over-heat, temperature collection loop failure
	Motor Connection	Motor non-connection, motor 3 phase parameter unbalance, parameter identification wrong
	Extension Card	Test and protect extension card compatible or conflict

Model Table

Voltage class	Model	Code	General load mode ([F0.15] =0)			Load mode for fan and water pump ([F0.15] =1)		
			Rated capacity (KVA)	Rated current (A)	Suitable motor (KW)	Rated capacity (KVA)	Rated current (A)	Suitable motor (KW)
Three phase 220V	E280-2T0022	000M580230022	3.8	10	2.2	-	-	-
	E280-2T0030	000M580230030	5.3	14	3	-	-	-
	E280-2T0040	000M580230040	6.5	17	4	-	-	-
	E280-2T0055	000M580230055	9.5	25	5.5	-	-	-
	E280-2T0075	000M580230075	12.6	33	7.5	-	-	-
	E280-2T0090	000M580230090	14.9	37	9	-	-	-
	E280-2T0110	000M580230110	17.5	46	11	-	-	-
	E280-2T0150	000M580230150	22.9	60	15	-	-	-
	E280-2T0185	000M580230185	28.6	75	18.5	-	-	-
	E280-2T0220	000M580230220	32.4	85	22	-	-	-
	E280-2T0300	000M580230300	41.9	110	30	-	-	-
	E280-2T0370	000M580230370	51.5	135	37	-	-	-
	E280-2T0450	000M580230450	64.8	170	45	-	-	-
	E280-2T0550	000M580230550	78.1	205	55	-	-	-
	E280-2T0750	000M580230750	101	265	75	-	-	-
E280-2T0900	000M580230900	122	320	90	-	-	-	
Three phase 380V	E280-4T0011G/4T0015P	000M580430011	2.0	3.0	1.1	2.4	3.7	1.5
	E280-4T0015G/4T0022P	000M580430015	2.4	3.7	1.5	3.6	5.5	2.2
	E280-4T0022G/4T0030P	000M580430022	3.6	5.5	2.2	4.9	7.5	3.0
	E280-4T0030G/4T0040P	000M580430030	4.9	7.5	3.0	6.3	9.5	4.0
	E280-4T0040G/4T0055P	000M580430040	6.3	9.5	4.0	8.6	13.0	5.5
	E280-4T0055G/4T0075P	000M580430055	8.6	13.0	5.5	11.2	17.0	7.5
	E280-4T0075G/4T0090P	000M580430075	11.2	17.0	7.5	13.8	21	9.0
	E280-4T0090G/4T0110P	000M580430090	13.8	21	9.0	16.5	25	11
	E280-4T0110G/4T0150P	000M580430110	16.5	25	11	21.7	32	15
	E280-4T0150G/4T0185P	000M580430150	21.7	32	15	25.7	37	18.5
	E280-4T0185G/4T0220P	000M580430185	25.7	37	18.5	29.6	45	22
	E280-4T0220G/4T0300P	000M580430220	29.6	45	22	39.5	60	30
	E280-4T0300G/4T0370P	000M580430300	39.5	60	30	49.4	75	37
	E280-4T0370G/4T0450P	000M580430370	49.4	75	37	62.5	95	45
	E280-4T0450G/4T0550P	000M580430450	62.5	95	45	75.7	115	55
	E280-4T0550G/4T0750P	000M580430550	75.7	115	55	98.7	150	75
	E280-4T0750G/4T0900P	000M580430750	98.7	150	75	116	176	90
	E280-4T0900G/4T1100P	000M580430900	116	176	90	138	210	110
	E280-4T1100G/4T1320P	000M580431100	138	210	110	171	260	132
	E280-4T1320G/4T1600P	000M580431320	171	260	132	204	310	160
	E280-4T1600G/4T1850P	000M580431600	204	310	160	237	360	185
	E280-4T1850G/4T2000P	000M580431850	237	360	185	253	385	200
	E280-4T2000G/4T2200P	000M580432000	253	385	200	276	420	220
	E280-4T2200G/4T2500P	000M580432200	276	420	220	313	475	250
	E280-4T2500G/4T2800P	000M580432500	313	475	250	352	535	280
E280-4T2800G/4T3150P	000M580432800	352	535	280	395	600	315	
E280-4T3150G/4T3500P	000M580433150	395	600	315	424	645	350	

Installation Size

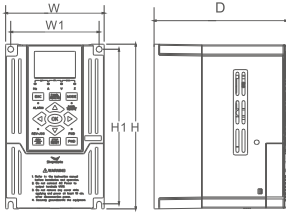

I Class applicable models
E280-4T0011G/4T0015P~
E280-4T0040G/4T0055P

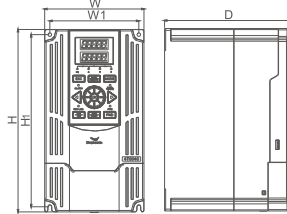

II Class applicable models
E280-4T0055G/4T0075P
~ E280-4T0300G/4T0370P,
E280-2T0022 ~ 2T0150

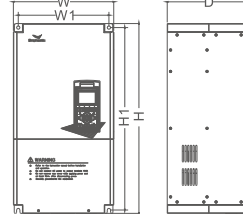

III Class applicable models
E280-4T0370G/4T0450P
~ E280-4T2200G/4T2500P,
E280-2T0185 ~ 2T0900

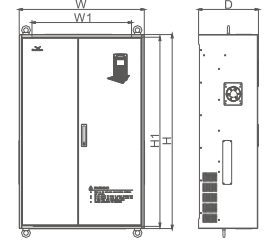

IV Class applicable models
E280-4T2500G/4T2800P~
E280-4T3150G/4T3500P

Model number (Three-phase 380V)	Model number (Three-phase 220V)	W1(mm)	W(mm)	H1(mm)	H(mm)	D(mm)	Screw (Spec.)
E280-4T0011G/0015P	-	87	97	152	162	130	M4
E280-4T0015G/0022P	-						
E280-4T0022G/0030P	-	95	105	190	200	146	M4
E280-4T0030G/0040P	-						
E280-4T0040G/0055P	-						
E280-4T0055G/0075P	E280-2T0022	121	135	234	248	175	M4
	E280-2T0030						
E280-4T0075G/0090P	E280-2T0040	146	160	261	275	179	M5
E280-4T0090G/0110P	-	169	180	290	305	179	M5
E280-4T0110G/0150P	E280-2T0055						
E280-4T0150G/0185P	E280-2T0075	160	210	387	405	202	M6
E280-4T0185G/0220P	E280-2T0090						
E280-4T0220G/0300P	E280-2T0110	160	250	422	445	216	M8
E280-4T0300G/0370P	E280-2T0150						
E280-4T0370G/0450P	E280-2T0185	271	300	545	567	250	M8
E280-4T0450G/0550P	E280-2T0220						
E280-4T0550G/0750P	E280-2T0300						
E280-4T0750G/0900P	E280-2T0370	344	381	588	614	298	M8
E280-4T0900G/1100P	E280-2T0450	380	510	710	740	270	M8
E280-4T1100G/1320P	E280-2T0550						
E280-4T1320G/1600P	E280-2T0750						
E280-4T1600G/1850P	E280-2T0900	400	580	760	793	300	M10
E280-4T1850G/2000P	-						
E280-4T2000G/2200P	-	550	700	960	1000	340	M10
E280-4T2200G/2500P	-						
E280-4T2500G/2800P	-	580	730	1103	1130	355	M10
E280-4T2800G/3150P	-						
E280-4T3150G/3500P	-						



SERVICE-HOT LINE
400-8819-800

Shenzhen Simphoenix Electric Technology Co.,Ltd

ADD: Building A, Huichao Industrial Park, 2nd Rd. of Gushu, Baoan Area,
Shenzhen, Guangdong.

TEL: (86)0755-26607756

FAX: (86)0755-26919882

WEB:www.simphoenix.com

Email:business01@sunfardrive.com